

# CUSTOM GARAGE DOORS



QUALITY  
GARAGE





IDC CUSTOM GARAGE DOORS

HANDCRAFTED GARAGE DOORS

Exceptional Engineering

We believe that custom garage doors should beautifully enhance the character of your home. That is why our garage doors create an immediate impression of quality and craftsmanship, offering quiet testimony to your personality and sense of style. And because they are a personal statement as well as a functional entrance to your home, we take our responsibility as craftsmen and engineers seriously.

Lasting Value

A custom garage door is an investment in the beauty and value of your home, and like any asset, it must retain its value over time. Feature for feature, our doors are designed and engineered to be the longest lasting garage doors in the industry.

With durable factory finishes, heavy duty components, cutting edge adhesives, and the best warranties available, IDC custom garage doors are built-to-last, not to be replaced.

Endless Possibilities

From rustic to refined, simple to ornate, we will help design the perfect door for your home. Choose from a wide range of wood species, decorative metals, architectural details, and wood finishes to create a door as unique and interesting as you.

With custom garage doors from IDC, the possibilities are endless but the end result is always the same: our commitment to your total satisfaction.



The Beauty of Details

With their natural wood beauty and lustrous finishes, our garage doors look like heirloom quality furniture, but in reality, they are the most technically advanced garage doors in the industry. Our hybrid wood+steel construction combines the timeless beauty of natural wood exteriors with the industry's most up-to-date engineering and finishing techniques.

The result is a custom garage door that strikes the perfect balance of beauty and long-lasting performance.



Classic Carriage Styles

These popular patterns echo the look of Swing Open and Sliding stable doors from the past. Shown: Arched three-pane windows, cross-buck patterns, copper kickplates, obscured glass, decorative hardware.



Integrating Entry Designs

Match your home's entry door design for a hot design trend. Shown: Modified eightpane windows with chamfered mullions, dentil molding, copper kickplates, matching stain.



Contemporary Form & Function

Clean lines, industrial materials, spare and functional designs look great with contemporary architecture. Shown (left): Horizontal half round T&G, clear windows. Shown (right): Natural copper panel overlay.



Woods & Finishes

Garage doors designed as part of an overall design plan that incorporates pattern designs, wood species, finishes and decorative elements. Shown: African mahogany, clear finish, copper kickplates, decorative cane bolts & clavos, obscured glass.

IDC 7 SERIES

PRODUCT FEATURES

Setting the Standard for Quality

- True custom doors complement the architectural integrity of your home.
- Exclusive IDC Limited Lifetime Warranty offers complete peace of mind.
- Hand-selected cedar, redwood, mahogany, fir & white oak from certified sustainable forests.
- Hybrid wood/steel construction produces stronger, more durable & safer door.
- Exceptional 12 R-value CFC-free Neufoam® polyurethane insulation.
- Long lasting, 25,000 cycle ISC springs engineered specifically for weight of door.
- Rubber gasketed sections & high density vinyl astragal for airtight fit.
- Matching stain or painted cedar weatherseal.
- Heavy duty nylon rollers for quiet operation.



Interior View



Cutaway View

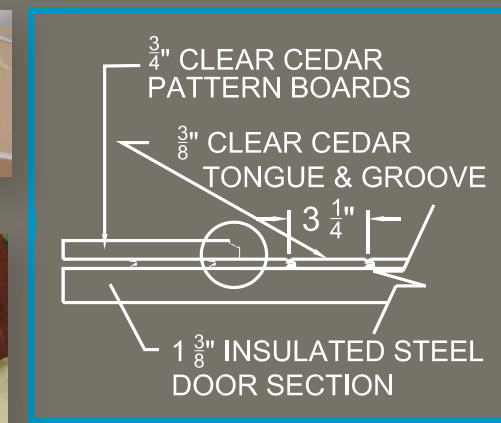

Section Detail

1

FROM CARRIAGE TO CONTEMPORARY

# DESIGNING YOUR CUSTOM GARAGE DOOR

## A Selection of Our Most Popular Door Designs

This collection of popular designs features a wide range of door styles that are beautiful on their own, or can be modified and accessorized to make a truly personal set of garage doors.

DESIGN CENTER

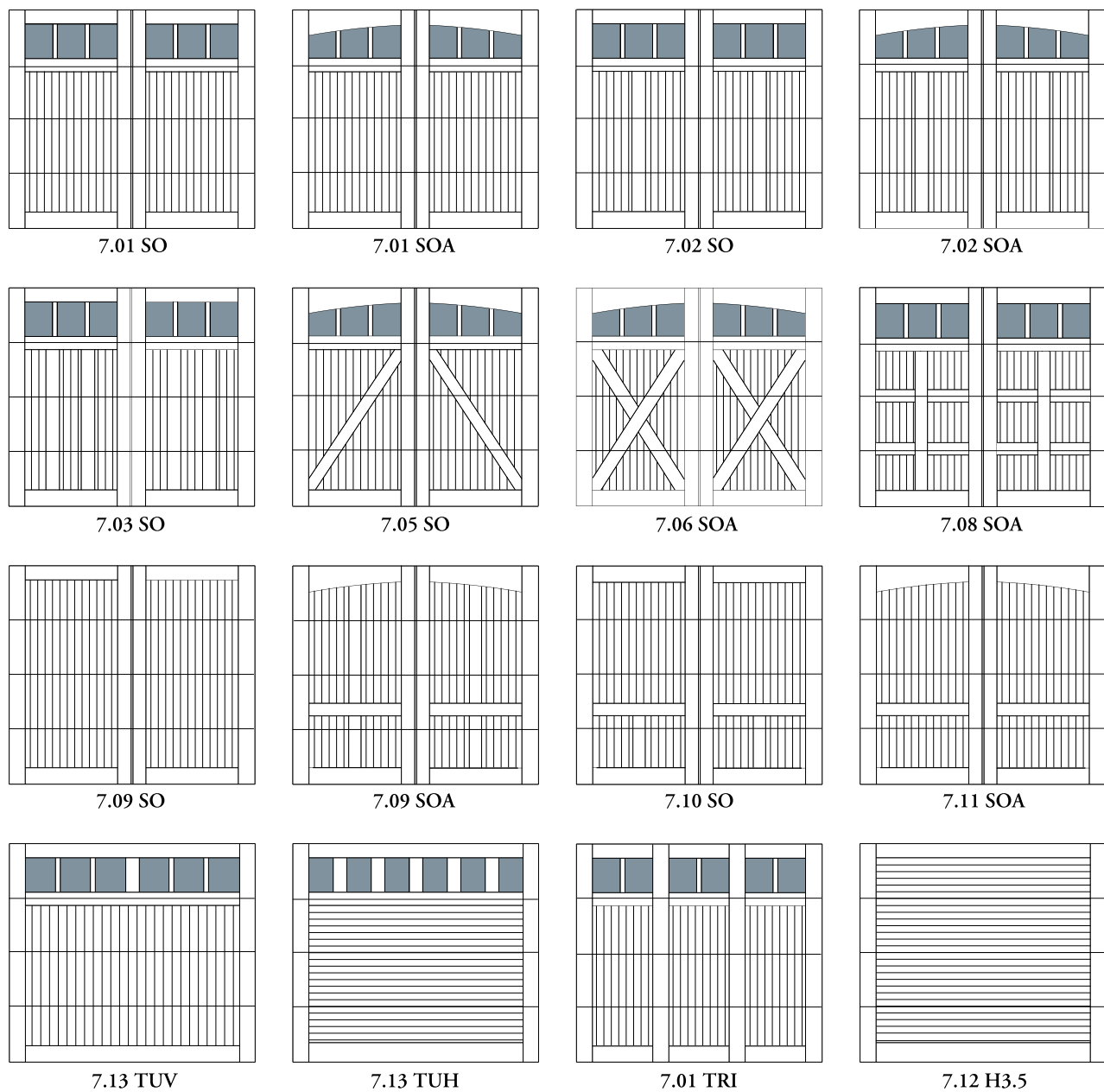

2

## Windows Styles that Brighten & Beautify

Choose a window pattern that complements the style of your home: from Colonial to Prairie, Contemporary to Four Square. All IDC windows are double-paned for exceptional warmth.

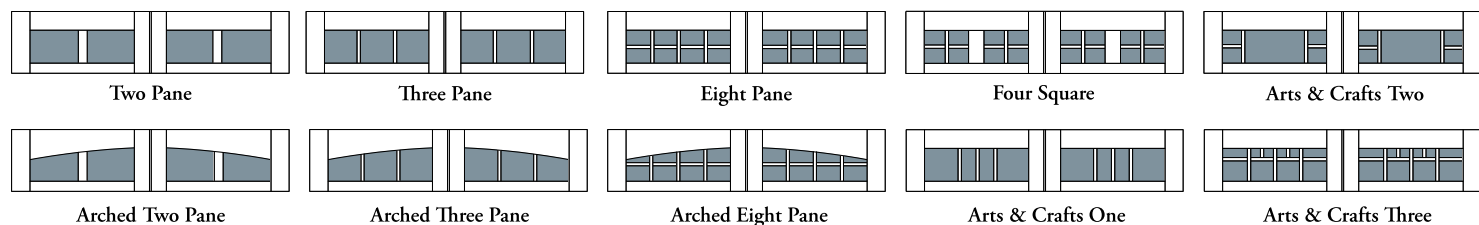

!

DESIGN ELEMENT

## Copper Kickplates



Eye-catching copper kickplates add beauty and protection to your door.

### Finish Options



3

## Decorative Hardware

Decorative hardware gives carriage door designs an element of authenticity and character. Choose from our collection of standard hardware or have us find something really unique, the choice is yours.

### Handles



Spade End (7" & 10")      Lis Style (7" & 10")      Colonial Bean (6" & 9")

### Ring Pulls



Lis Knocker (6") w/ 4" ring      Traditional Ring Pull (3 1/2") w/ base      Ring Pull (4 1/2")      Twisted Ring Pull (4")

### Lever Handles



Lis Style Handle Set (8")



Traditional Handle Set (6")



Lis Style Door Latch (10")



Traditional Door Latch (8") w/ 3 1/2" Ring

### Latches

### Strap Hinges



Fleur de Lis Style Hinge (16")



Spade End Hinge (16" shown w/ Nail Studs)



Colonial Bean Hinge (16")



Spade End Hinge (10")



L Corner and T Brackets (9" x 9")

### Clavos

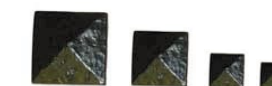

Pyramid Clavos (2", 1 1/2", 1 1/8" & 3/4")



Iron Door Studs (3/4")



Round Clavos (2", 1 3/4", 1 1/4" & 3/4")

4

## Edge Profiles

Edge profiles are subtle details that harmonize the look of your garage door.

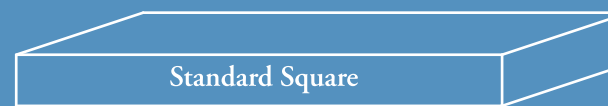



BOLD AND BEAUTIFUL

# PREMIUM DOOR COLLECTION

Unique Custom Garage Doors

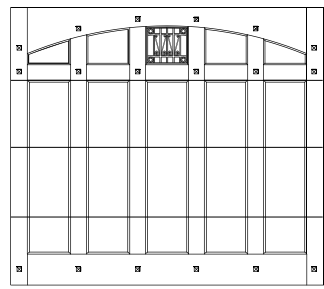

DC-0808

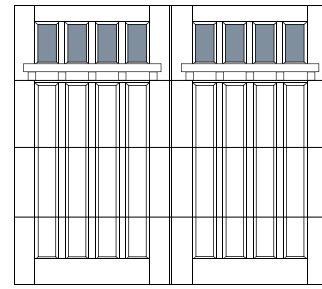

DC-0723

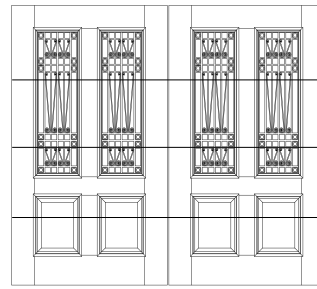

DC-0824

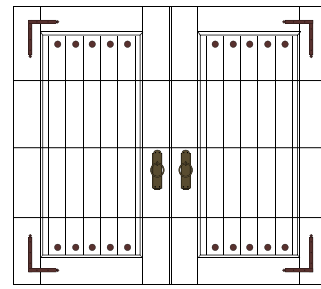

DC-0711

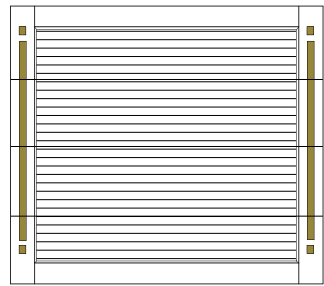

DC-0701

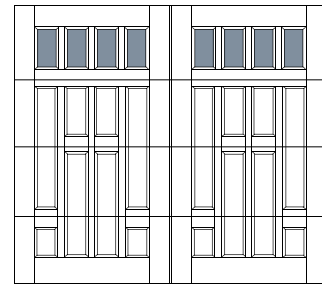

DC-0724

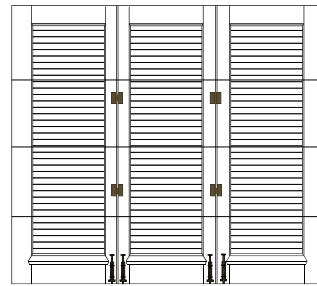

DC-0616

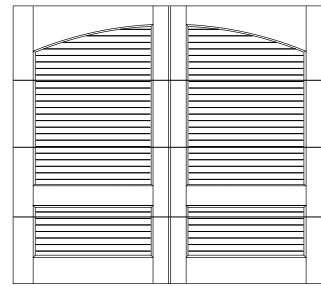

DC-0615

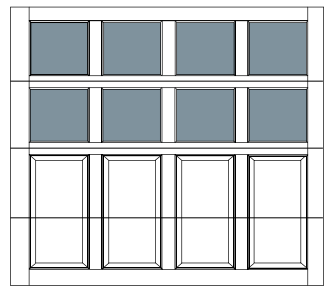

DC-0709

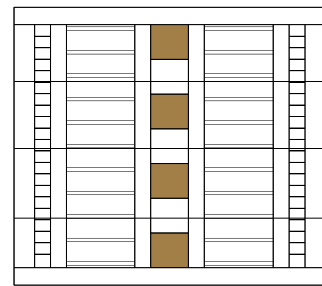

DC-0802

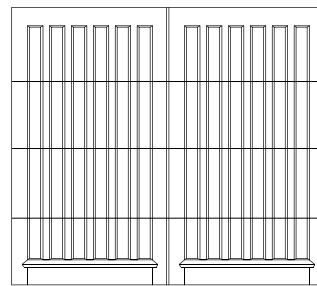

DC-0703



DC-0704

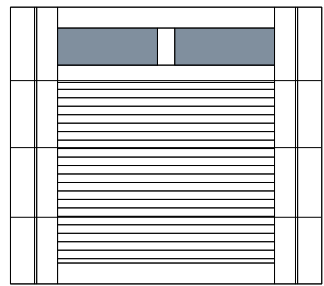

DC-0620

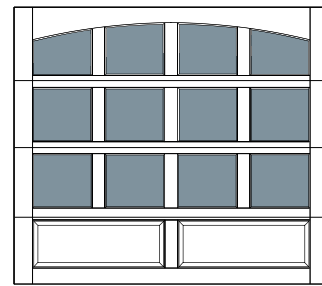

DC-0710

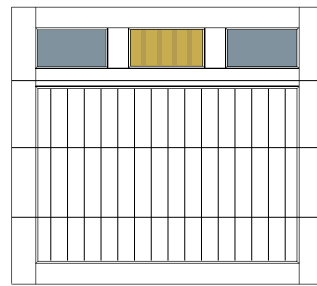

DC-0600

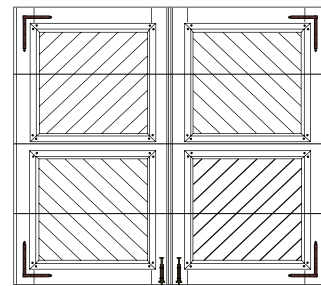

DC-0715



THE EXTRA TOUCH

## IDC Custom Services



### Service Doors

Our 7 Series insulated service doors are designed for beauty and warmth.



### Shutters

Our custom wood shutters add charm and character.



### Custom Finishes

Our Custom Match capabilities give you complete design freedom.

As seen on HGTV:



## COMPARING WOOD FINISHES

In a controlled test environment by an independent third party (1500 hrs. Xenon Arc & Weatherometer exposure), the Euro X system outperformed the leading North American Brand in all tested criteria:

- (1) fading, (2) cracking,
- (3) chipping & (4) blistering.

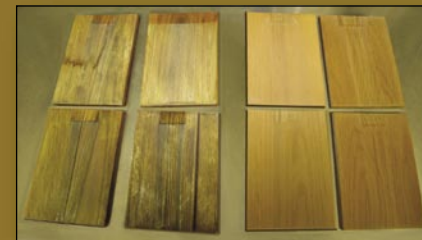

This photo shows the dramatic difference between IDC's Euro X Finish System (on the right) and the leading North American Brand (on the left) in a simulation of 5 years of weathering.

Best of all, the Euro X maintenance coat is an environmentally friendly, water-based clearcoat that is easy to apply in all climates.



COMPREHENSIVE COLOR SELECTION

## IDC'S EURO X FINISH SYSTEM

We proudly feature Euro X Exterior Finishes by M. L. Campbell, the most durable, easy-to-maintain wood finish available.



ULTRA COOL

## Distressed Finishes

Give your doors an antique appearance with our distressed finishes and glazes.

From rugged Wirebrushed to European Antique, your doors will have instant character.

Shown: Wirebrushed w/ Crimson Fire

## 7 SERIES LIMITED LIFETIME WARRANTY

IDC's 7 Series doors hybrid wood/steel construction offers specific benefits over traditionally constructed, all-wood garage doors including lower overall maintenance, increased insulation value and significantly greater durability. Because of their hybrid construction utilizing both man-made and natural materials, Industrial Door Company, Inc. warrants the components of the 7 Series door system as follows:

### 1. STEEL SECTION PANELS: LIMITED LIFETIME WARRANTY

Industrial Door Company, Inc. warrants the steel 'sandwich' sections against deterioration due to "rust through," "delamination," and cracking or peeling paint to the original purchaser for as long as he or she owns the home in which the door was installed.

### 2. ADHESION OF WOOD OVERLAY TO STEEL SECTION PANELS: LIMITED LIFETIME WARRANTY\*

For all 7 Series doors, IDC warrants the door system against delamination between the wood overlay and steel sections to the original purchaser for as long as he or she owns the home in which the door was installed provided homeowner properly maintains door following IDC's 7 Series recommended care & maintenance instructions.\*\*

### 3. PARTS AND LABOR: 2 YEAR WARRANTY

Industrial Door Company, Inc. warrants all on-door hardware components and spring assemblies used in the 7 Series door system against defects in material and workmanship for a period of 2 years from the date of delivery to the original purchaser. Under terms of this limited warranty, any on-door hardware on a 7 Series door system, installed by an authorized Industrial Door Company, Inc. representative, found to be defective upon inspection by authorized Industrial Door Company, Inc. personnel, will be replaced free of charge.

#### \* WARRANTY LIMITATIONS:

*Section, wood overlay adhesion, and hardware warranties do not extend to normal wear or deterioration resulting from harmful fumes, excessive salts, vandalism, animal waste, or foreign substances in the atmosphere. Nor shall the warranties extend as a result of any physical damage caused to the door after the door left the manufacturing plant or failure to provide reasonable, necessary and/or proper maintenance, to cover any damages with respect to any products that in any way or degree have been altered, processed, misused or improperly installed or handled.*

*Any charges for freight, removal, installation or painting shall be the responsibility of the original purchaser.*

#### \*\* IMPORTANT CARE INFORMATION

*NOTE: THIS PRODUCT REQUIRES PERIODIC MAINTENANCE. Due to the nature of wood as a natural product that requires proper sealing and maintenance, this warranty does not, nor is it intended to extend to the wood applied to the exterior of the door (i.e. cracking, rotting, splitting, twisting, warping) that is possible with wood.*

*All wood material must be stained/sealed and/or painted within 48 hours after installation with an approved finish system. Allow the stain or paint to dry, and then finish coat the door with a minimum of two coats of exterior grade oil or water based polyurethane. Every two years thereafter, the exterior wood surface must be re-coated with an additional two coats of oil or water-based polyurethane. This product, like all other wood products, requires a regularly scheduled maintenance program to ensure the wood does not prematurely degrade.*

*IDC's factory applied finishes are designed to offer superior protection against water and UV damage, however, all exterior finishes will*

www.idcdoors.com



THINK DIFFERENTLY ABOUT GARAGE DOORS™

**Industrial Door Company, Inc.**  
**360 Coon Rapids Blvd. NW**  
**Minneapolis, MN 55433**

**763-786-4730 / 888-798-0199**

